



NUVOLA CHROME



NUVOLA CZ

1



2

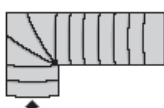

2

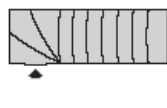

2/B

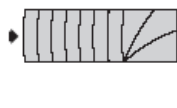

2/2

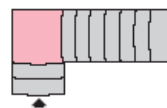

2/B

3



3

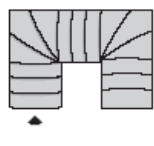

3/1

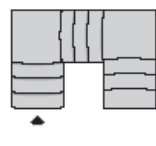

3B/1

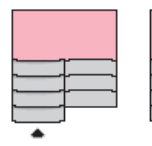

3A

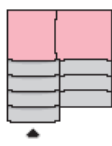

3B

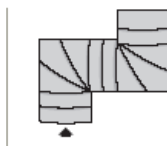

3S

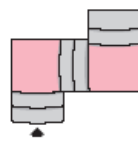

3SB

Solo 800÷1000

4

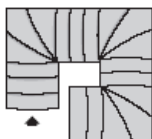

4

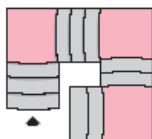

4B

Legenda
Key
Légende
Zeichenerklärung
Leyenda

a: alzata
a: riser
a: Hauteur
a: Tritthöhe/Steigung
a: Contrahuella

P: pedata
P: step
P: giron
P: Trittfläche
P: huella

G: gradino
G: tread
G: Marche
G: Stufe
G: Peldano

H: altezza
H: high
H: Hauteur
H: Hoehe
H: Altura

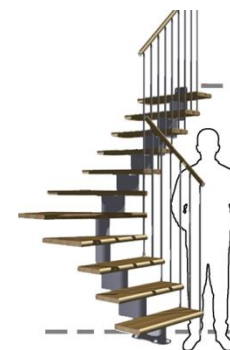
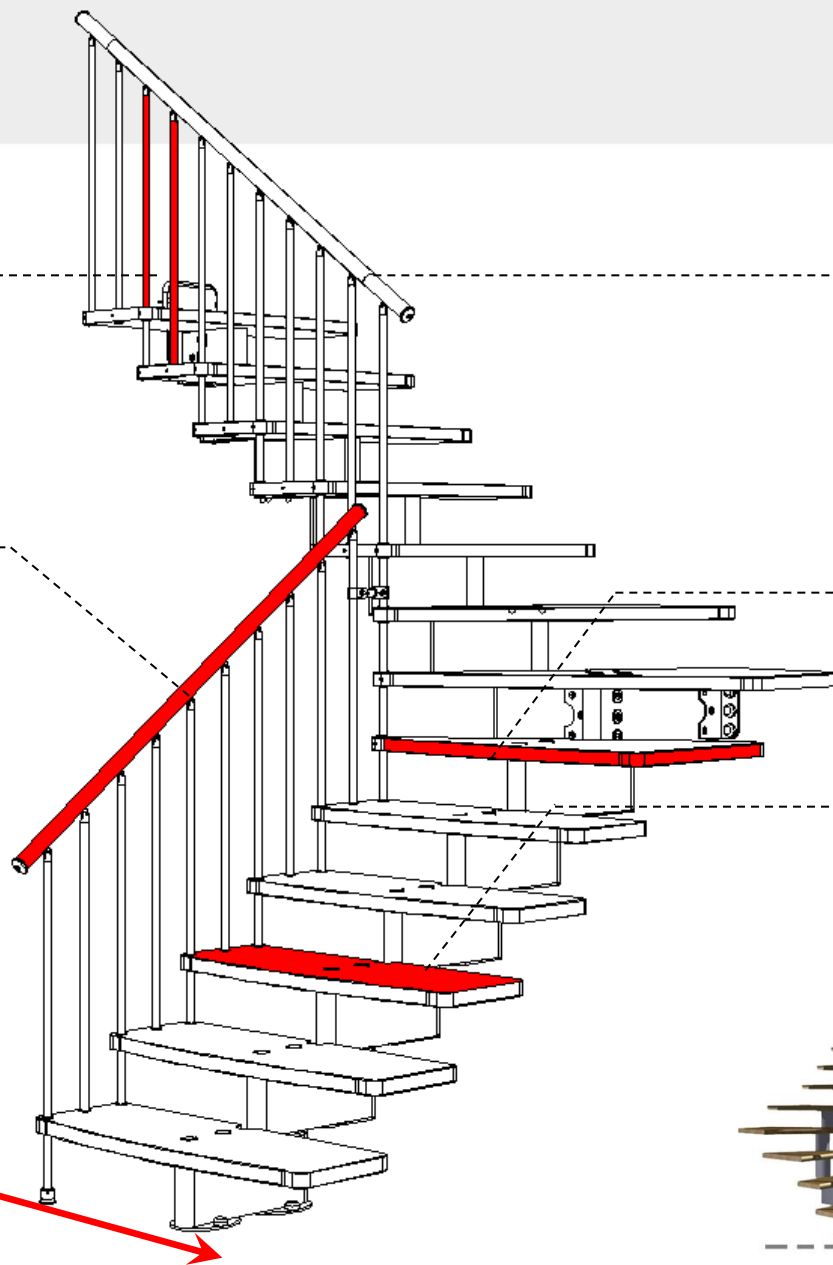
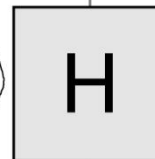
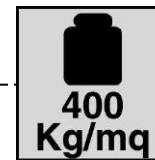
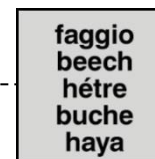
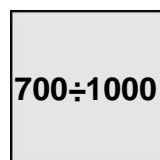
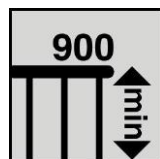
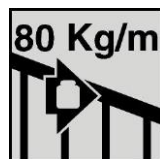
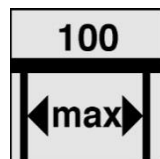

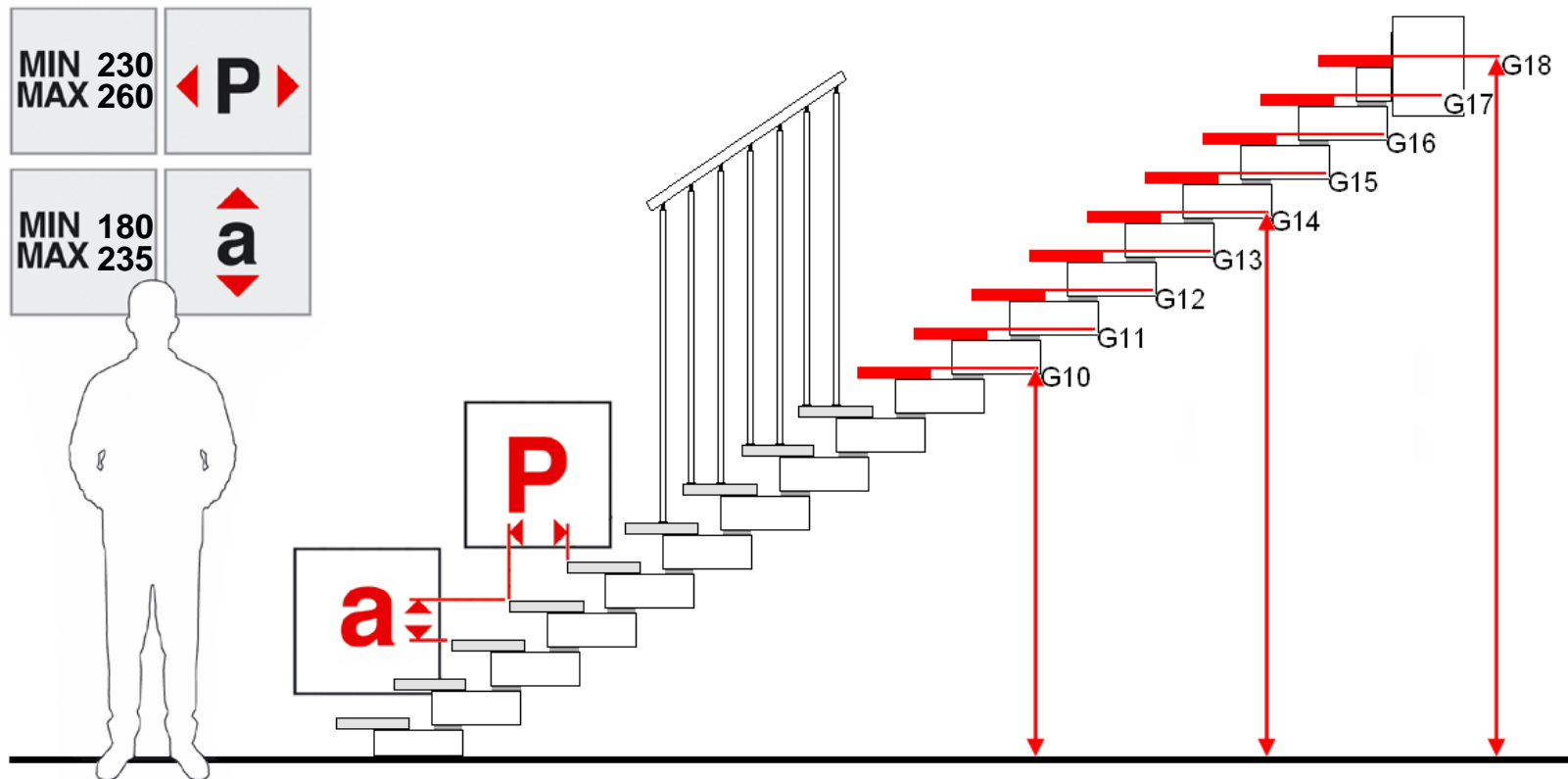

G10	G11	G12	G13	G14	G15	G16	G17	G18
h	h	h	h	h	h	h	h	h
1930	2105	2280	2455	2630	2805	2980	3155	3330
2330	2545	2760	2975	3190	3405	3620	3835	4050

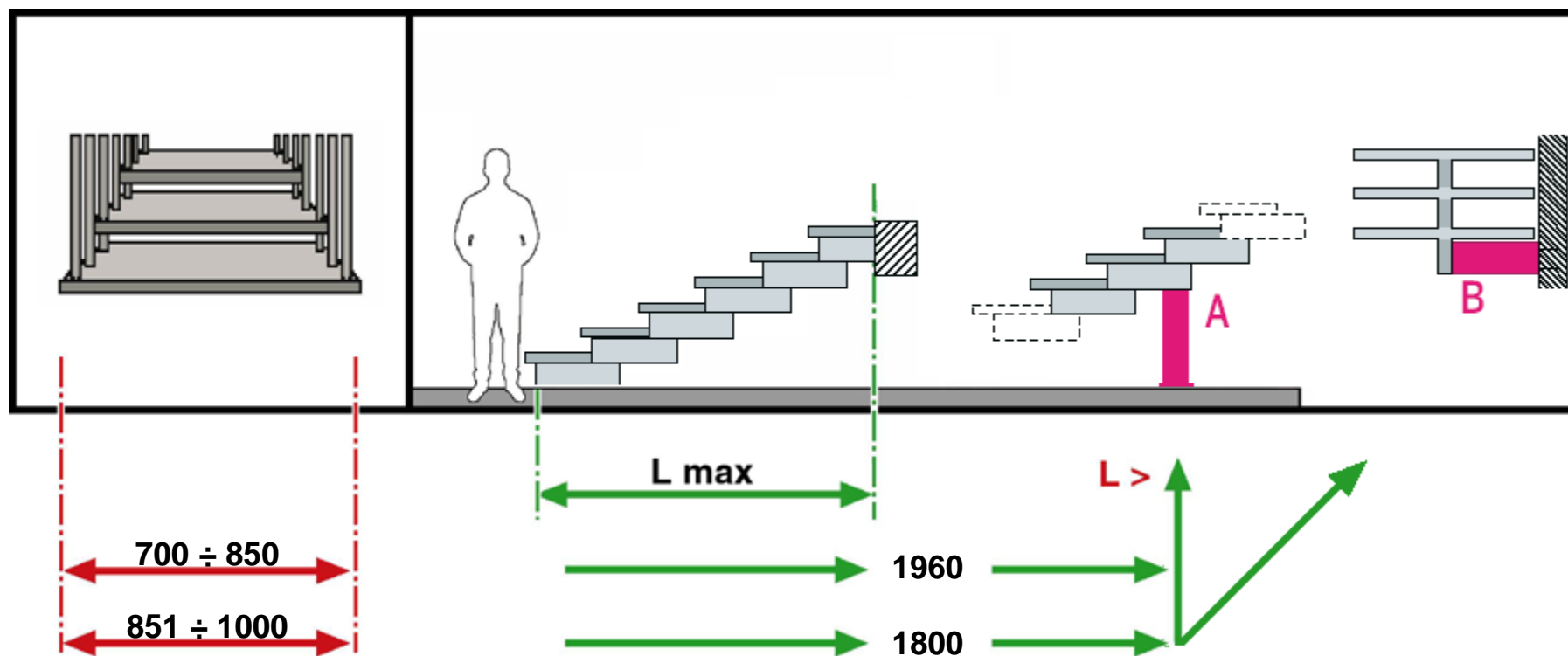

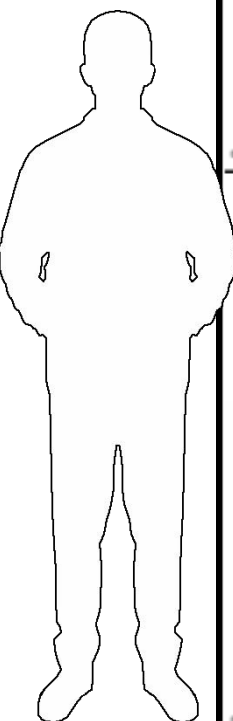

			h	h	h	h	h	h	h	h	h	h	h	h	
			G4	G5	G6	G7	G8	G9	G10	G11	G12	G13	G14	G15	
230			175	139	314	489	664	839	1014	1189	1364	1539	1714	1889	2064
			180	144	324	504	684	864	1044	1224	1404	1584	1764	1944	2124
			185	149	334	519	704	889	1074	1259	1444	1629	1814	1999	2184
			190	154	344	534	724	914	1104	1294	1484	1674	1864	2054	2244
			195	159	354	549	744	939	1134	1329	1524	1719	1914	2109	2304
			200	164	364	564	764	964	1164	1364	1564	1764	1964	2164	2364
			205	169	374	579	784	989	1194	1399	1604	1809	2014	2219	2424
			210	174	384	594	804	1014	1224	1434	1644	1854	2064	2274	2484
			215	209	424	639	854	1069	1284	1499	1714	1929	2144	2359	2574
			220	214	434	654	874	1094	1314	1534	1754	1974	2194	2414	2634
			225	219	444	669	894	1119	1344	1569	1794	2019	2244	2469	2694
			230	224	454	684	914	1144	1374	1604	1834	2064	2294	2524	2754
260			175	314	489	664	839	1014	1189	1364	1539	1714	1889	2064	2239
			180	324	504	684	864	1044	1224	1404	1584	1764	1944	2124	2304
			185	334	519	704	889	1074	1259	1444	1629	1814	1999	2184	2369
			190	344	534	724	914	1104	1294	1484	1674	1864	2054	2244	2434
			195	354	549	744	939	1134	1329	1524	1719	1914	2109	2304	2499
			200	364	564	764	964	1164	1364	1564	1764	1964	2164	2364	2564
			205	374	579	784	989	1194	1399	1604	1809	2014	2219	2424	2629
			210	384	594	804	1014	1224	1434	1644	1854	2064	2274	2484	2694
			215	424	639	854	1069	1284	1499	1714	1929	2144	2359	2574	2789
			220	434	654	874	1094	1314	1534	1754	1974	2194	2414	2634	2854
			225	444	669	894	1119	1344	1569	1794	2019	2244	2469	2694	2919
			230	454	684	914	1144	1374	1604	1834	2064	2294	2524	2754	2984

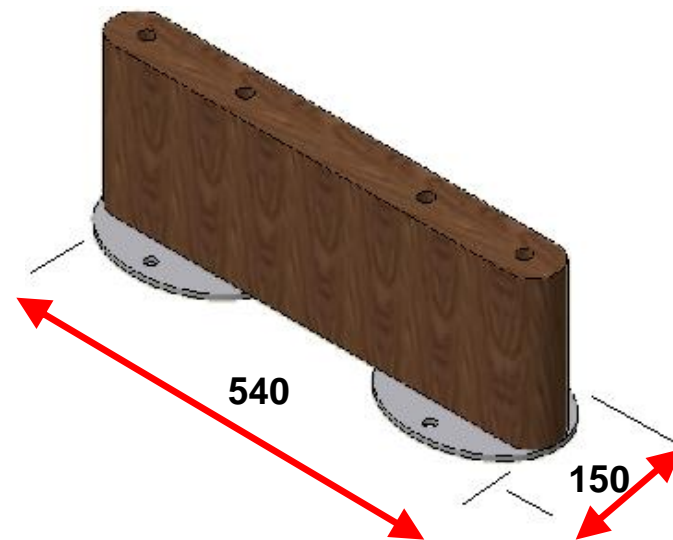
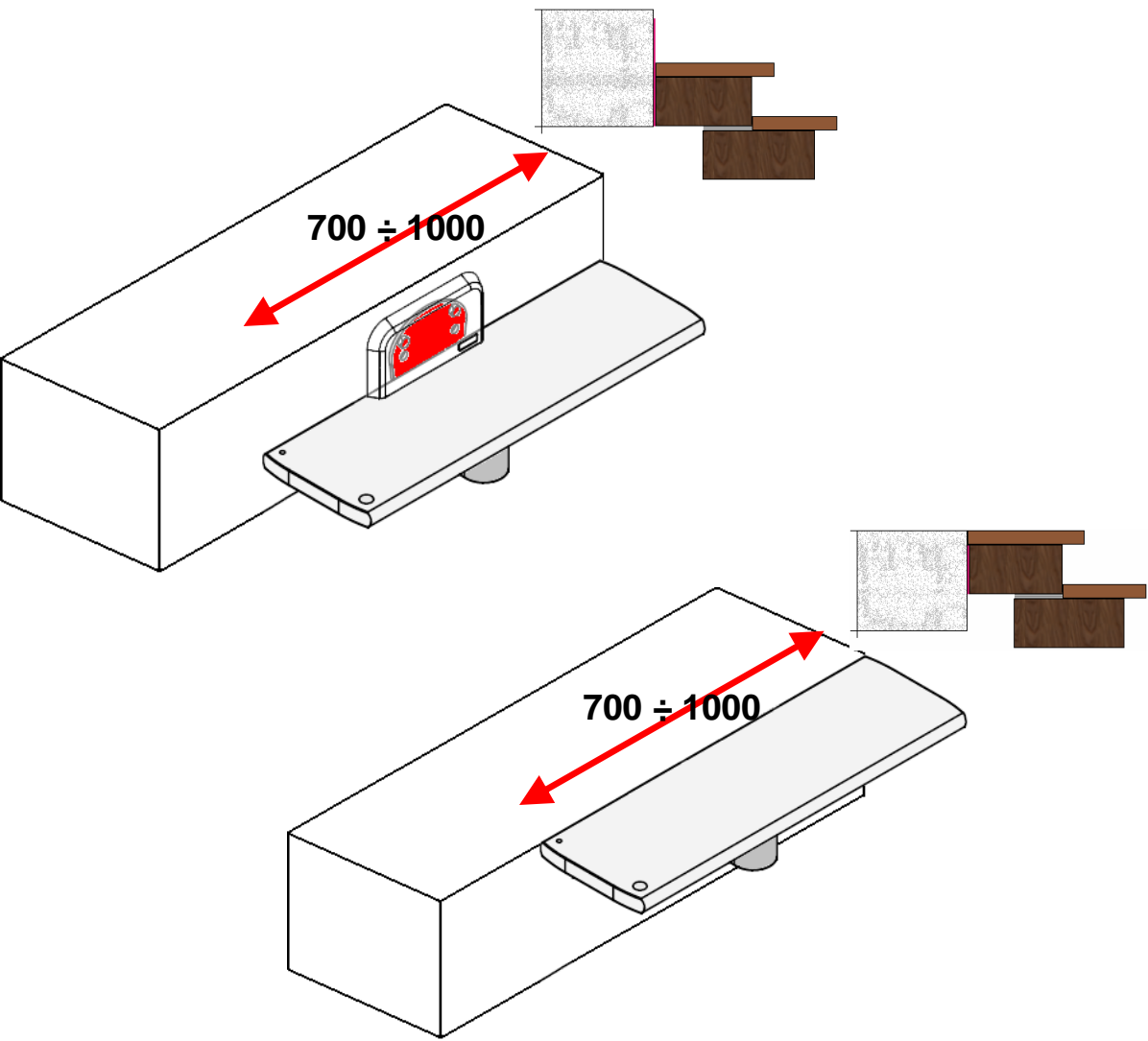

SC

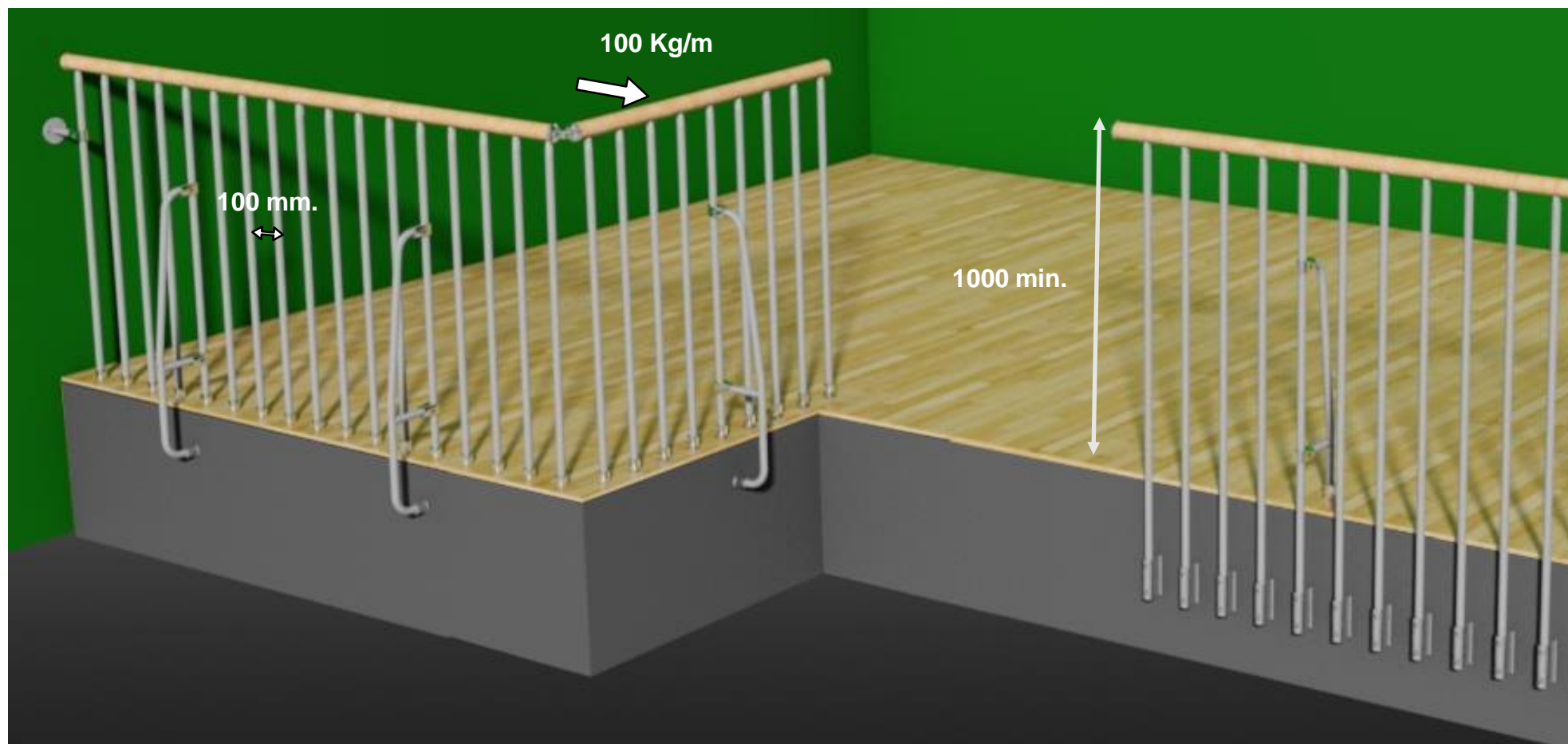

CHROME

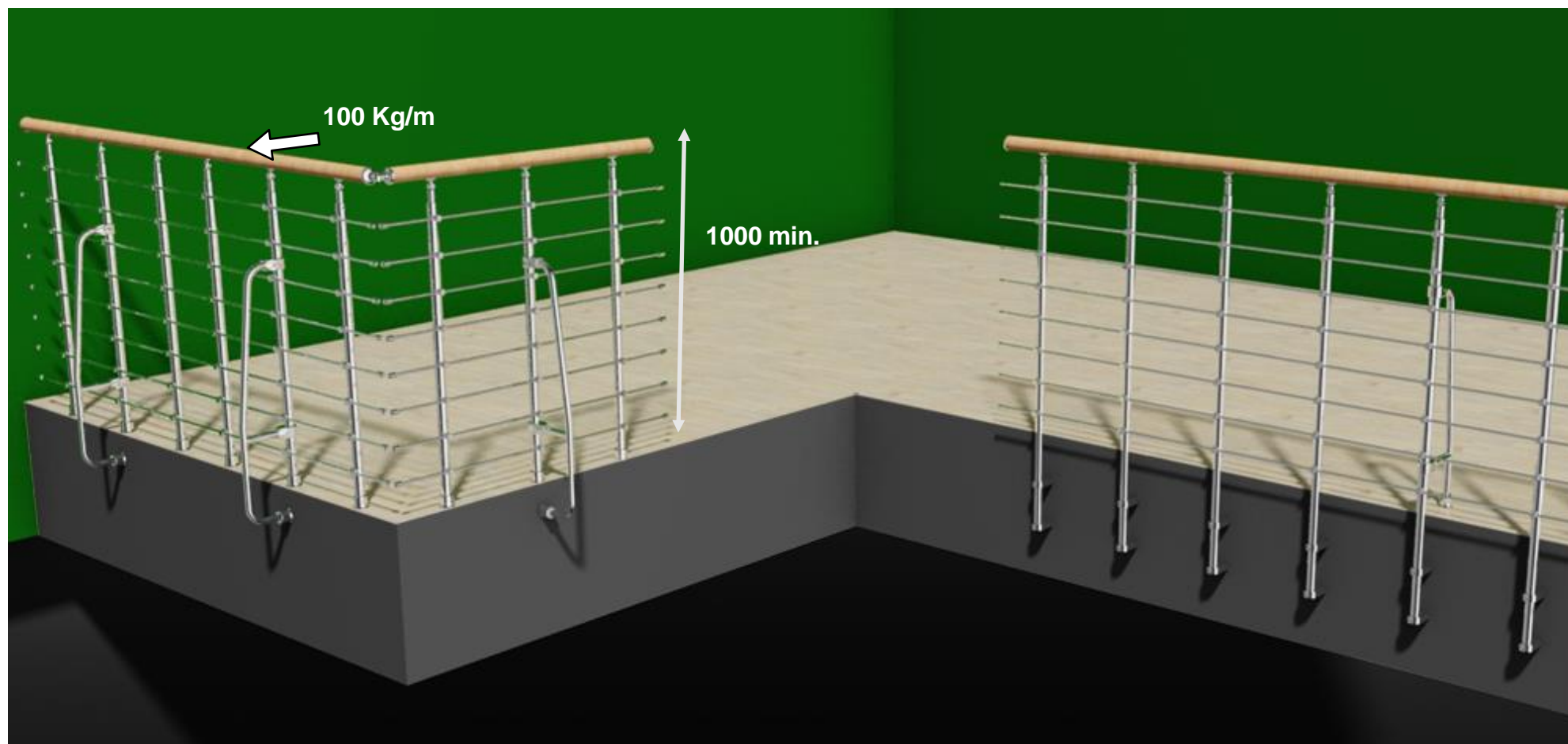

**COLORI
DEL
FAGGIO**

									
252 Noce medio Beech/light chestnut. Buche/Nussbaumholz.	253 Naturale Beech/natural. Buche/Naturbuchenholz.	258 Rovere Beech/oak. Buche/Eichenholz.	287 Ciliegio Beech/cherry stain. Buche/Kirschholz.	289 Doussié Beech/doussié. Buche/Doussié.	311 Sbiancato Fir/whitened wood. Fichte/Bleichesholz.	312 Wenghè Fir/wenghè. Fichte/Wenghè.	400 Grigio Fir/grey. Fichte/grau.	410 Cacao Cacao. Kakao.	420 Sabbia Sand. Sandfarben.
									
430 Tortora Dove grey. Taubengrau.	401 DEC Grigio Beech/grey. Buche/grau.	411 DEC Cacao Cacao. Kakao.	421 DEC Sabbia Sand. Sandfarben.	431 DEC Tortora Dove grey. Taubengrau.					

**COLORI
DEL
METALLO**



RAL 9007
Grigio metallizzato
Metal gray
Aluminium Grau